

USB-3105

16 analog voltage output (16-bit)
Eight digital I/O, one 32-bit event counter
Full-speed USB 2.0 device

User's Guide



USB-3105

USB-based Analog Output

User Guide



**MEASUREMENT
COMPUTING™**

Document Revision 3A, March, 2009
© Copyright 2009, Measurement Computing Corporation

Trademark and Copyright Information

Measurement Computing Corporation, InstaCal, Universal Library, and the Measurement Computing logo are either trademarks or registered trademarks of Measurement Computing Corporation. Refer to the Copyrights & Trademarks section on mccdaq.com/legal for more information about Measurement Computing trademarks. Other product and company names mentioned herein are trademarks or trade names of their respective companies.

© 2009 Measurement Computing Corporation. All rights reserved. No part of this publication may be reproduced, stored in a retrieval system, or transmitted, in any form by any means, electronic, mechanical, by photocopying, recording, or otherwise without the prior written permission of Measurement Computing Corporation.

Notice

Measurement Computing Corporation does not authorize any Measurement Computing Corporation product for use in life support systems and/or devices without prior written consent from Measurement Computing Corporation. Life support devices/systems are devices or systems that, a) are intended for surgical implantation into the body, or b) support or sustain life and whose failure to perform can be reasonably expected to result in injury. Measurement Computing Corporation products are not designed with the components required, and are not subject to the testing required to ensure a level of reliability suitable for the treatment and diagnosis of people.

Table of Contents

Preface

About this User's Guide	6
What you will learn from this user's guide.....	6
Conventions in this user's guide.....	6
Where to find more information	6

Chapter 1

Introducing the USB-3105	7
Overview: USB-3105 features	7
USB-3105 block diagram	8
Software features	8

Chapter 2

Installing the USB-3105	9
What comes with your USB-3105 shipment?	9
Hardware.....	9
Additional documentation.....	9
Unpacking the USB-3105	9
Installing the software.....	10
Installing the hardware.....	10
Connecting the USB-3105 to your system.....	10
Calibrating the USB-3105	11

Chapter 3

Functional Details	12
External components.....	12
USB connector.....	12
Status LED.....	12
Power LED	13
Screw terminal banks	13
Analog voltage output terminals (VOUT0 to VOUT15)	14
Digital I/O terminals (DIO0 to DIO7)	14
Digital I/O control terminal (DIO CTL) for pull-up/down configuration	15
Ground terminals (AGND, DGND)	15
Synchronous DAC load terminal (SYNCLD).....	15
Counter terminal (CTR).....	15
Power terminal (+5V)	16
Synchronizing multiple units	16

Chapter 4

Specifications	17
Analog voltage output.....	17
Analog output calibration	18
Digital input/output.....	18
Synchronous DAC Load	19
Counter	19
Memory	20
Microcontroller.....	20
Power.....	20
USB specifications.....	20
Environmental.....	20

Mechanical.....	21
Main connector and pin out	21
Declaration of Conformity	22

About this User's Guide

What you will learn from this user's guide

This user's guide describes the Measurement Computing USB-3105 data acquisition board and lists hardware specifications.

Conventions in this user's guide

For more information

Text presented in a box signifies additional information related to the subject matter.

Caution! Shaded caution statements present information to help you avoid injuring yourself and others, damaging your hardware, or losing your data.

bold text **Bold** text is used for the names of objects on a screen, such as buttons, text boxes, and check boxes.

italic text *Italic* text is used for the names of manuals and help topic titles, and to emphasize a word or phrase.

Where to find more information

Additional information about USB-3105 hardware is available on our website at www.mccdaq.com. You can also contact Measurement Computing Corporation with specific questions.

- Knowledgebase: kb.mccdaq.com
- Tech support form: www.mccdaq.com/support/support_form.aspx
- Email: techsupport@mccdaq.com
- Phone: 508-946-5100 and follow the instructions for reaching Tech Support

For international customers, contact your local distributor. Refer to the International Distributors section on our website at www.mccdaq.com/International.

Introducing the USB-3105

Overview: USB-3105 features

This user's guide contains all of the information you need to connect the USB-3105 to your computer and to the signals you want to control. The USB-3105 is part of the Measurement Computing brand of USB-based data acquisition products.

The USB-3105 is a USB 2.0 full-speed device that is supported under popular Microsoft® Windows® operating systems. The USB-3105 is fully compatible with both USB 1.1 and USB 2.0 ports.

The USB-3105 provides 16 channels of analog voltage output, eight digital I/O connections, and one 32-bit event counter.

The USB-3105 has four quad (4-channel) 16-bit digital-to-analog converters (DAC). You set the voltage output range of each DAC channel independently with software for either bipolar or unipolar. The bipolar range is ± 10 V, and the unipolar range is 0 to 10 V. The analog outputs may be updated individually or simultaneously. A bidirectional synchronization connection allows you to simultaneously update the DAC outputs on multiple devices.

The USB-3105 features eight bidirectional digital I/O connections. You can configure the DIO lines as input or output in one 8-bit port. All digital pins are floating by default. A screw terminal connection is provided for pull-up (+5 V) or pull-down (0 volts) configuration.

The 32-bit counter can count TTL pulses.

The USB-3105 is powered by the +5 volt USB supply from your computer. No external power is required. All I/O connections are made to the screw terminals located along each side of the USB-3105.

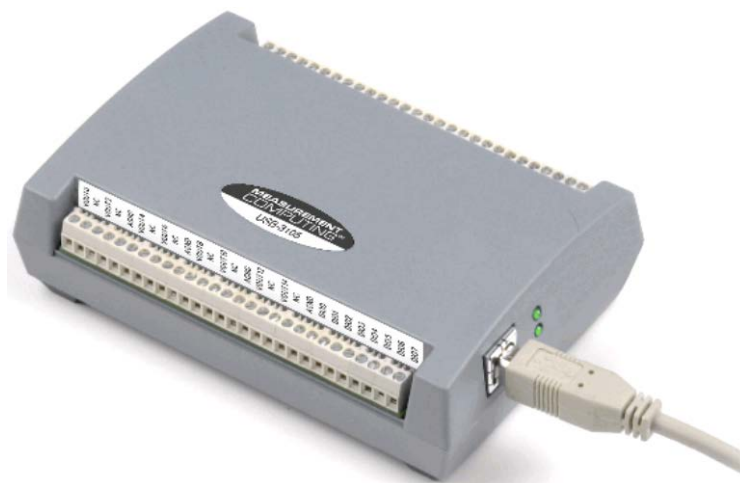

Figure 1. USB-3105

USB-3105 block diagram

USB-3105 functions are illustrated in the block diagram shown here.

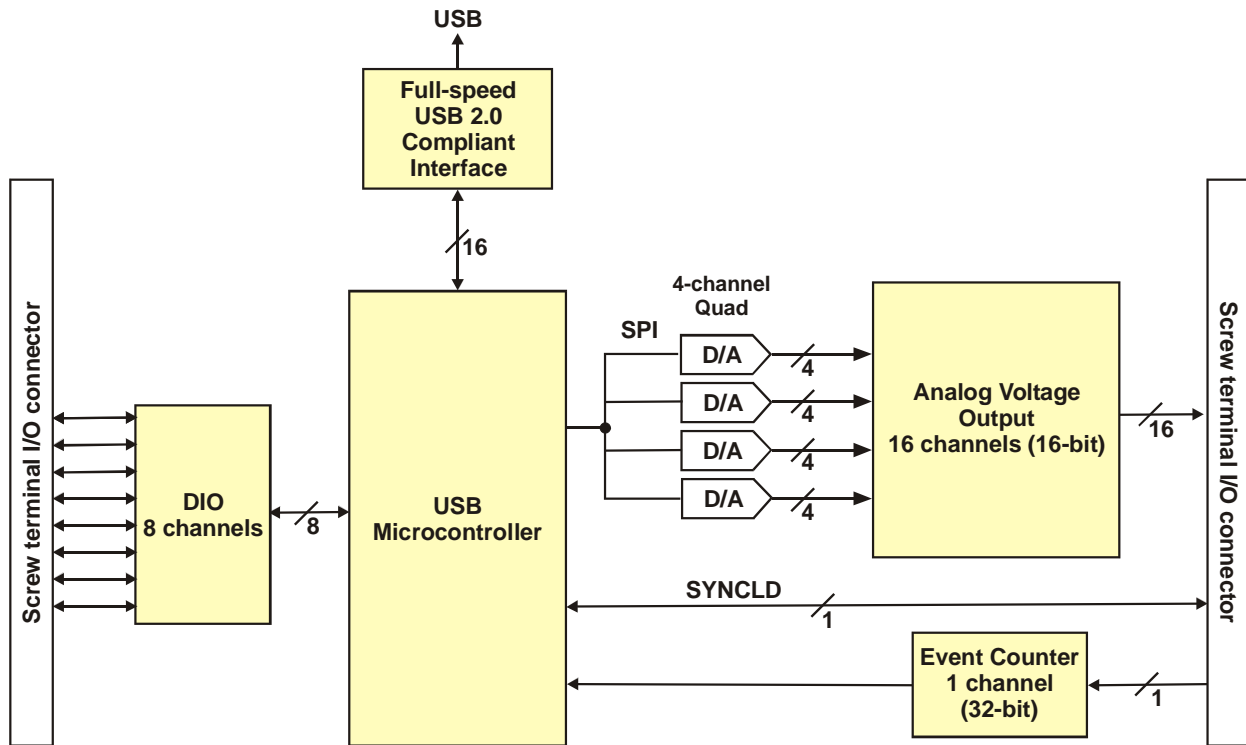

Figure 2. USB-3105 block diagram

Software features

For information on the features of *InstaCal* and the other software included with your USB-3105, refer to the *Quick Start Guide* that shipped with your device. The *Quick Start Guide* is also available in PDF at www.mccdaq.com/PDFs/manuals/DAQ-Software-Quick-Start.pdf.

Check www.mccdaq.com/download.htm for the latest software version.

Installing the USB-3105

What comes with your USB-3105 shipment?

The following items are shipped with the USB-3105.

Hardware

- USB-3105 device



- USB cable (2 meter length)



Additional documentation

In addition to this hardware user's guide, you should also receive the *Quick Start Guide* (available in PDF at www.mccdaq.com/PDFs/manuals/DAQ-Software-Quick-Start.pdf). This booklet supplies a brief description of the software you received with your USB-3105 and information regarding installation of that software. Please read this booklet completely before installing any software or hardware.

Unpacking the USB-3105

As with any electronic device, you should take care while handling to avoid damage from static electricity. Before removing the USB-3105 from its packaging, ground yourself using a wrist strap or by simply touching the computer chassis or other grounded object to eliminate any stored static charge.

If any components are missing or damaged, notify Measurement Computing Corporation immediately by phone, fax, or e-mail:

- Phone: 508-946-5100 and follow the instructions for reaching Tech Support.
- Fax: 508-946-9500 to the attention of Tech Support
- Email: techsupport@mccdaq.com

Installing the software

Refer to the *Quick Start Guide* for instructions on installing the software on the *Measurement Computing Data Acquisition Software CD*. This booklet is available in PDF at www.mccdaq.com/PDFs/manuals/DAQ-Software-Quick-Start.pdf.

Installing the hardware

Be sure you are using the latest system software

Before you connect the USB-3105, make sure that you are using the latest versions of the USB drivers.

Before installing the USB-3105, download and install the latest Microsoft Windows updates. In particular, when using Windows XP, make sure you have XP Hotfix KB822603 installed. This update is intended to address a serious error in Usbport.sys when you operate a USB device. You can run Windows Update or download the update from www.microsoft.com/downloads/details.aspx?familyid=733dd867-56a0-4956-b7fe-e85b688b7f86&displaylang=en. For more information, refer to the Microsoft Knowledge Base article "Availability of the Windows XP SP1 USB 1.1 and 2.0 update." This article is available at support.microsoft.com/?kbid=822603.

Connecting the USB-3105 to your system

To connect the USB-3105 to your system, turn your computer on, and connect the USB cable to a USB port on your computer or to an external USB hub that is connected to your computer. The USB cable provides power and communication to the USB-3105.

When you connect the USB-3105 for the first time, a **Found New Hardware** popup balloon (Windows XP) or dialog (other Windows versions) appears as the USB-3105 is detected by your computer.



After the USB-3105 is installed, the popup balloon or dialog states "Your new hardware is installed and ready to use," and the power LED should flash and then remain lit. This indicates that communication is established between the USB-3105 and your computer.



Caution! Do not disconnect **any** device from the USB bus while the computer is communicating with the USB-3105, or you may lose data and/or your ability to communicate with the USB-3105.

If the power LED turns off

If the power LED is illuminated but then turns off, the computer has lost communication with the USB-3105. To restore communication, disconnect the USB cable from the computer, and then reconnect it. This should restore communication, and the power LED should turn back *on*.

Calibrating the USB-3105

The USB-3105 is shipped fully calibrated. Calibration coefficients are stored in the device FLASH memory. Return the device to Measurement Computing Corporation when calibration is required. The normal calibration interval is once per year.

Functional Details

External components

The USB-3105 has the following external components, as shown in Figure 3.

- USB connector
- Status LED
- Power LED
- Screw terminal banks (2)

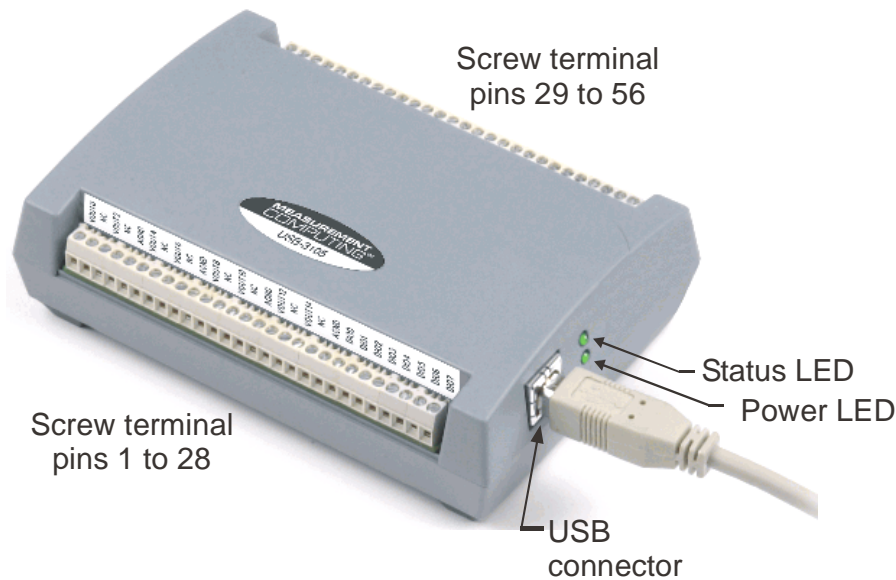

Figure 3. USB-3105 external components

USB connector

The USB connector provides power and communication to the USB-3105. The voltage supplied through the USB connector is system-dependent, and may be less than 5 V. No external power supply is required.

Status LED

The Status LED indicates the communication status of the USB-3105. It flashes when data is being transferred, and is off when the USB-3105 is not communicating. This LED uses up to 10 mA of current and cannot be disabled.

Power LED

The power LED lights up when the USB-3105 is connected to a USB port on your computer or to an external USB hub that is connected to your computer.

Screw terminal banks

The USB-3105 has two rows of screw terminals—one row on the top edge of the housing, and one row on the bottom edge. Each row has 28 connections. Use 16 AWG to 30 AWG wire gauge when making screw terminal connections. Pin numbers are identified in Figure 4.

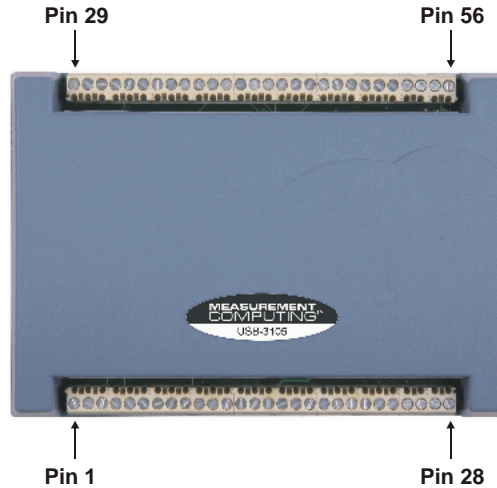

Figure 4. USB-3105 screw terminal pin numbering

Screw terminal – pins 1-28

The screw terminals on the bottom edge of the USB-3105 (pins 1 to 28) provide the following connections:

- Eight analog voltage output connections (**VOUT0**, **VOUT2**, **VOUT4**, **VOUT6**, **VOUT8**, **VOUT10**, **VOUT12**, **VOUT14**)
- Four analog ground connections (**AGND**)
- Eight digital I/O connections (**DIO0** to **DIO7**)

Screw terminal – pins 29-56

The screw terminals on the top edge of the USB-3105 (pins 29 to 56) provide the following connections:

- Eight analog voltage output connections (**VOUT1**, **VOUT3**, **VOUT5**, **VOUT7**, **VOUT9**, **VOUT11**, **VOUT13**, **VOUT15**)
- Four analog ground connections (**AGND**)
- One SYNC terminal for external clocking and multi-unit synchronization (**SYNCLD**)
- Three digital ground connections (**DGND**)
- One external event counter connection (**CTR**)
- One digital I/O pull-down resistor connection (**DIO CTL**)
- One voltage output power connection (**+5V**)

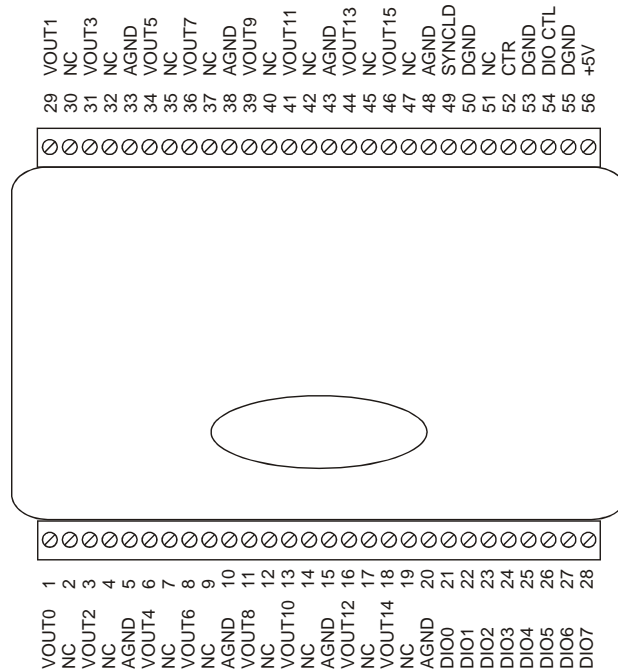

Figure 5. USB-3105 signal pin out

Analog voltage output terminals (VOUT0 to VOUT15)

The screw terminal pins labeled **VOUT0** to **VOUT15** are voltage output terminals (see Figure 5). The voltage output range for each channel is software-programmable for either bipolar or unipolar. The bipolar range is ± 10 V, and the unipolar range is 0 to 10 V. The channel outputs may be updated individually or simultaneously.

Digital I/O terminals (DIO0 to DIO7)

You can connect up to eight digital I/O lines to the screw terminals labeled **DIO0** to **DIO7** (pins 21 through 28). You can configure each digital bit for either input or output.

When you configure the digital bits for input, you can use the digital I/O terminals to detect the state of any TTL level input. Refer to the switch shown in Figure 6 and the schematic shown in Figure 7. When the switch is set to the +5 V USER input, DIO7 reads *TRUE* (1). If you move the switch to DGND, DIO7 reads *FALSE* (0).

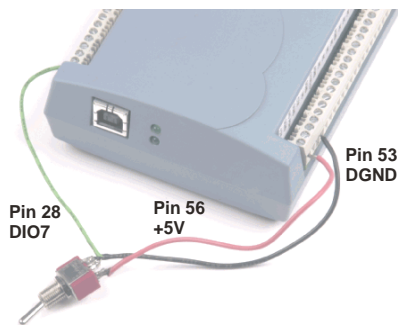

Figure 6. DIO7 detecting the state of a switch

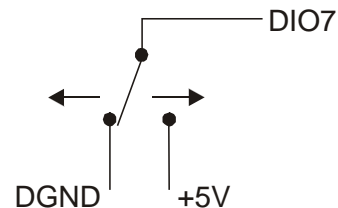

Figure 7. Schematic showing DIO7 detecting the state of a switch

For more information on digital signal connections

For more information on digital signal connections and digital I/O techniques, refer to the *Guide to Signal Connections* (available on our web site at www.mccdaq.com/pdfs/DAQ-Signal-Connections.pdf).

Digital I/O control terminal (DIO CTL) for pull-up/down configuration

All digital pins are floating by default. When inputs are floating, the state of unwired inputs are undefined (they may read high or low). You can configure the inputs to read a high or low value when they aren't wired. Use the **DIO CTL** connection (pin 54) to configure the digital pins for pull-up (inputs read high when unwired) or pull-down (inputs read low when unwired).

- To pull up the digital pins to +5V, wire the **DIO CTL** terminal pin to the **+5V** terminal pin (pin 56).
- To pull down the digital pins to ground (0 volts), wire the **DIO CTL** terminal pin to a **DGND** terminal pin (pin 50, 53, or 55).

Ground terminals (AGND, DGND)

Eight analog ground (**AGND**) connections provide a common ground for all analog voltage output channels. Three digital ground (**DGND**) connections provide a common ground for the **DIO**, **CTR**, **SYNCLD** and **+5V** connections.

Synchronous DAC load terminal (SYNCLD)

The synchronous DAC load connection (pin 49) is a bidirectional I/O signal that allows you to simultaneously update the DAC outputs on multiple devices. You can use this pin for two purposes:

- Configure as an input (slave mode) to receive the D/A LOAD signal from an external source.
When the SYNCLD pin receives the trigger signal, the analog outputs are updated simultaneously.

SYNCLD pin must be logic low in slave mode for immediate update of DAC outputs

When the SYNCLD pin is in slave mode, the analog outputs can be updated immediately or when a positive edge is seen on the SYNCLD pin (this is under software control.)

The SYNCLD pin must be at a low logic level for DAC outputs to update immediately. If the external source supplying the D/A LOAD signal is pulling the SYNCLD pin high, no update will occur.

Refer to the "USB-3100 Series" section in the *Universal Library User's Guide* for information on how to update DAC outputs immediately.

- Configure as an output (master mode) to send the internal D/A LOAD signal to the SYNCLD pin.
You can use the SYNCLD pin to synchronize with a second USB-3105 and simultaneously update the DAC outputs on each device. Refer to [Synchronizing multiple units](#) on page 17.

Use *InstaCal* to configure the SYNCLD mode as master or slave. On power up and reset the SYNCLD pin is set to slave mode (input).

Refer to the "USB-3100 Series" section in the *Universal Library User's Guide* for information on how to configure the USB-3105 with the Universal Library.

Counter terminal (CTR)

The **CTR** connection (pin 52) is the input to the 32-bit event counter. The internal counter increments when the TTL levels transition from low to high. The counter can count frequencies of up to 1 MHz.

Power terminal (+5V)

The **+5 V** connection (pin 56) draws power from the USB connector. This terminal is a +5V output.

Caution! The +5V terminal is an output. Do not connect to an external power supply or you may damage the USB-3105 and possibly the computer.

Synchronizing multiple units

You can connect the **SYNCLD** terminal pin (pin 49) of two USB-3105 units together in a master/slave configuration and simultaneously update the DAC outputs of both devices. Do the following.

1. Connect the SYNCLD pin of the master USB-3105 to the SYNCLD pin of the slave USB-3105.
2. Configure the SYNCLD pin on the slave device for input to receive the D/A LOAD signal from the master device. Use *InstaCal* to set the direction of the SYNCLD pin.
3. Configure the SYNCLD pin on the master device for output to generate an output pulse on the SYNCLD pin.

Set the Universal Library `SIMULTANEOUS` option for each device. Refer to the *Universal Library User's Guide* for information on how to configure the USB-3105 with the Universal Library.

When the SYNCLD pin on the slave device receives the signal, the analog output channels on each device are updated simultaneously.

An example of a master/slave configuration is shown here.

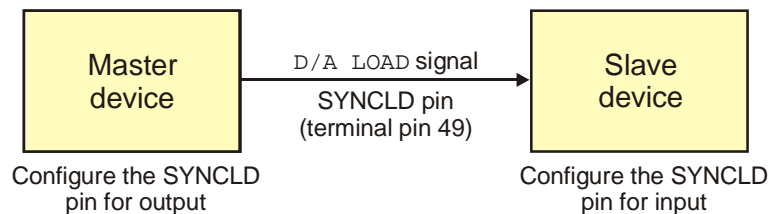

Figure 8. Synchronizing the update of multiple devices

Specifications

Typical for 25 °C unless otherwise specified.

Specifications in *italic text* are guaranteed by design.

Analog voltage output

Table 1. Analog voltage output specifications

Parameter	Conditions	Specifications
Digital to Analog converter		DAC8554
Number of channels		16
Resolution		16 bits
Output ranges	Calibrated	± 10 V, 0 to 10 V Software configurable
	Un-calibrated	± 10.2 V, -0.04 to 10.08 V Software configurable
Output transient	± 10 V to (0 to 10 V) or (0 to 10 V) to ± 10 V range selection. (Note 1)	Duration: 5 μ S typ. Amplitude: 5V p-p typ.
	Host PC is reset, powered on, suspended or a reset command is issued to device. (Note 2)	Duration: 2 S typ. Amplitude: 2V p-p typ.
	Initial power on.	Duration: 50 mS typ. Amplitude: 5V peak typ.
Differential non-linearity (Note 3)	Calibrated	± 1.25 LSB typ. -2 LSB to +1 LSB max.
	Un-calibrated	± 0.25 LSB typ. ± 1 LSB max.
Output current	VOUTx pins	± 3.5 mA typ.
Output short-circuit protection	VOUTx connected to AGND	Indefinite
Output coupling		DC
Power on and reset state		DACs cleared to zero-scale: 0 V, ± 50 mV typ.
		Output range: 0-10V
Output noise	0 to 10 V range	14.95 μ Vrms typ.
	± 10 V range	31.67 μ Vrms typ.
<i>Settling time</i>	<i>to 1 LSB accuracy</i>	<i>25 μS typ.</i>
Slew rate	0 to 10 V range	1.20 V/ μ S typ.
	± 10 V range	1.20 V/ μ S typ.
Throughput	Single-channel	100 Hz max., system dependent
	Multi-channel	100 Hz/#ch max., system dependent

Note 1: The USB-3105 output voltage level defaults to 0V whenever the output voltage range is reconfigured.

The USB-3105 output voltage level will also default to 0V:

- 1) Whenever the host PC is reset, shut down or suspended.
- 2) If a reset command is issued to the device

Note 2: The duration of this particular output transient is highly dependent on the enumeration process of the host PC. Typically the output of the USB-3105 is stable after 2 seconds.

Note 3: The maximum differential non-linearity specification applies to the entire 0 to 70 °C temperature range of the USB-3105. This specification also accounts for the maximum errors due to the software calibration algorithm (in Calibrated mode only) and the DAC8554 digital to analog converter non-linearities.

Table 2. Absolute accuracy specifications – calibrated output

Range	Accuracy (\pm LSB)
± 10 V	14.0
0 to 10 V	22.0

Table 3. Absolute accuracy components specifications – calibrated output

Range	% of reading	Offset (\pm mV)	Temp drift (%/°C)	Absolute accuracy at FS (\pm mV)
± 10 V	± 0.0183	1.831	0.00055	3.661
0 to 10 V	± 0.0183	0.915	0.00055	2.746

Table 4. Relative accuracy specifications

Range	Relative accuracy (\pm LSB)	
± 10 V , 0 to 10 V	4.0 typ.	12.0 max.

Analog output calibration

Table 5. Analog output calibration specifications

Parameter	Conditions	Specifications
Recommended warm-up time		15 minutes min.
On-board precision reference		DC level: 5.000 V \pm 1 mV max.
		Tempco: ± 10 ppm/°C max.
		Long term stability: ± 10 ppm/SQRT(1000 hrs)
Calibration method		Software calibration
Calibration interval		1 year

Digital input/output

Table 6. Digital I/O specifications

Digital logic type	CMOS
Number of I/O	8
Configuration	Independently configured for input or output
Pull-up/pull-down configuration (Note 4)	User configurable All pins floating (default)
Digital I/O input loading	TTL (default)
	47K ohms (pull-up/pull down configurations)
Digital I/O transfer rate (system paced)	System dependent, 33 to 1000 port reads/writes or single bit reads/writes per second.
Input high voltage	2.0 V min, 5.5 V absolute max
Input low voltage	0.8 V max, -0.5 V absolute min
Output high voltage (IOH = -2.5 mA)	3.8 V min
Output low voltage (IOL = 2.5 mA)	0.7 V max
Power on and reset state	Input

Note 4: Pull up and pull down configuration area available using the DIO CTL terminal block pin 54. The pull down configuration requires the DIO CTL pin (pin 54) to be connected to a DGND pin (pin 50, 53 or 55). For a pull up configuration, the DIO CTL pin should be connected to the +5V terminal pin (pin 56).

Synchronous DAC Load

Table 7. SYNCLD I/O specifications

Parameter	Conditions	Specification
Pin name		SYNCLD (terminal block pin 49)
Power on and reset state		Input
Pin type		Bidirectional
Termination		Internal 100K ohms pull-down
Software selectable direction	Output	Outputs internal D/A LOAD signal.
	Input	Receives D/A LOAD signal from external source.
Input clock rate		100 Hz max
Clock pulse width	Input	1 μ s min
	Output	5 μ s min
<i>Input leakage current</i>		$\pm 1.0 \mu$ A <i>typ.</i>
Input high voltage		4.0 V min, 5.5 V absolute max
Input low voltage		1.0 V max, -0.5 V absolute min
Output high voltage (Note 5)	IOH = -2.5 mA	3.3 V min
	No load	3.8 V min
Output low voltage (Note 6)	IOL = 2.5 mA	1.1 V max
	No load	0.6 V max

Note 5: SYNCLD is a Schmitt trigger input and is over-current protected with a 200 Ohm series resistor.

Note 6: When SYNCLD is in input mode, the analog outputs may either be updated immediately or when a positive edge is seen on the SYNCLD pin (this is under software control.) However, the pin must be at a low logic level in order for the DAC outputs to be updated immediately. If an external source is pulling the pin high, no update will occur.

Counter

Table 8. CTR I/O specifications

Parameter	Conditions	Specification
Pin name		CTR
Number of channels		1
Resolution		32-bits
Counter type		Event counter
Input type		TTL, rising edge triggered
Counter read/writes rates (software paced)	Counter read	System dependent, 33 to 1000 reads per second.
	Counter write	System dependent, 33 to 1000 reads per second.
Schmidt trigger hysteresis		20 mV to 100 mV
<i>Input leakage current</i>		$\pm 1.0 \mu$ A <i>typ.</i>
Input frequency		1 MHz max.
<i>High pulse width</i>		500 nS <i>min.</i>
<i>Low pulse width</i>		500 nS <i>min.</i>
Input high voltage		4.0 V min, 5.5 V absolute max
Input low voltage		1.0 V max, -0.5 V absolute min

Memory

Table 9. Memory specifications

EEPROM	256 bytes		
EEPROM configuration	Address range	Access	Description
	0x000-0x0FF	Read/write	256 bytes user data

Microcontroller

Table 10. Microcontroller specifications

<i>Type</i>	<i>High performance 8-bit RISC microcontroller</i>
<i>Program memory</i>	<i>16,384 words</i>
<i>Data memory</i>	<i>2,048 bytes</i>

Power

Table 11. Power specifications

Parameter	Conditions	Specification
Supply current	USB enumeration	< 100 mA
Supply current (Note 7)	Quiescent current	200 mA typ.
+5V user output voltage range (Note 8)	Available at terminal block pin 56	4.5 V min, 5.25 V max.
+5V user output current (Note 9)	Available at terminal block pin 56	10 mA max.

Note 7: This is the total quiescent current requirement for the USB-3105 which includes up to 10 mA for the status LED. This does not include any potential loading of the digital I/O bits, +5V user terminal, or the VOUTx outputs.

Note 8: Output voltage range assumes USB power supply is within specified limits.

Note 9: This refers to the total amount of current that can be sourced from the +5V user terminal (pin 56) for general use. This specification also includes any additional contribution due to DIO loading.

USB specifications

Table 12. USB specifications

USB device type	USB 2.0 (full-speed)
USB device compatibility	USB 1.1, 2.0
USB cable length	3 meters max.
<i>USB cable type</i>	<i>A-B cable, UL type AWM 2527 or equivalent (min 24 AWG VBUS/GND, min 28 AWG D+/D-).</i>

Environmental

Table 13. Environmental specifications

Operating temperature range	0 to 70 °C
Storage temperature range	-40 to 85 °C
Humidity	0 to 90% non-condensing

Mechanical

Table 14. Mechanical specifications

Dimensions	127 mm (L) x 88.9 mm (W) x 35.56 (H)
------------	--------------------------------------

Main connector and pin out

Table 15. Main connector specifications

Connector type	Screw terminal
Wire gauge range	16 AWG to 30 AWG

Pin	Signal Name	Pin	Signal Name
1	VOUT0	29	VOUT1
2	NC	30	NC
3	VOUT2	31	VOUT3
4	NC	32	NC
5	AGND	33	AGND
6	VOUT4	34	VOUT5
7	NC	35	NC
8	VOUT6	36	VOUT7
9	NC	37	NC
10	AGND	38	AGND
11	VOUT8	39	VOUT9
12	NC	40	NC
13	VOUT10	41	VOUT11
14	NC	42	NC
15	AGND	43	AGND
16	VOUT12	44	VOUT13
17	NC	45	NC
18	VOUT14	46	VOUT15
19	NC	47	NC
20	AGND	48	AGND
21	DIO0	49	SYNCLD
22	DIO1	50	DGND
23	DIO2	51	NC
24	DIO3	52	CTR
25	DIO4	53	DGND
26	DIO5	54	DIO CTL
27	DIO6	55	DGND
28	DIO7	56	+5V

CE Declaration of Conformity

Manufacturer: Measurement Computing Corporation
Address: 10 Commerce Way
Suite 1008
Norton, MA 02766
USA

Measurement Computing Corporation declares under sole responsibility that the product

USB-3105

to which this declaration relates is in conformity with the relevant provisions of the following standards or other documents:

Category: Electrical equipment for measurement, control and laboratory use.

EC EMC Directive 2004/108/EC: Electromagnetic Compatibility, EN 61326-1:2006, (IEC 61326-1:2005)

Emissions:

- EN 55011 (1990)/CISPR 11 Radiated emissions: Group 1, Class A
- EN 55011 (1990)/CISPR 11 Conducted emissions: Group 1, Class B

Immunity: EN61326-1:2006, (IEC 61326-1:2005) Table 3 Immunity requirements for equipment used in controlled EM environments.

- IEC 61000-4-2 (2001): Electrostatic Discharge immunity.
- IEC 61000-4-3 (2002): Radiated Electromagnetic Field immunity.

To maintain the safety, emission, and immunity standards of this declaration, the following conditions must be met.

- The host computer, peripheral equipment, power sources, and expansion hardware must be CE compliant.
- Equipment must be operated in a controlled electromagnetic environment as defined by Standards EN 61326-1:2006, or IEC 61326-1:2005.
- Shielded wires must be used for all I/Os and must be less than 3 meters (9.75 feet) in length.
- The host computer must be properly grounded.
- The host computer must be USB2.0 compliant.
- A protective ESD wrist strap should be used when connecting or disconnecting leads from screw terminal blocks.

Note: Data acquisition equipment may exhibit noise or increased offsets when exposed to high RF fields (>1V/m) or transients.

Declaration of Conformity based on tests conducted by Chomerics Test Services, Woburn, MA 01801, USA in January, 2007. Test records are outlined in Chomerics Test Report #EMI4712.07. Further testing was conducted by Chomerics Test Services, Woburn, MA. 01801, USA in November, 2008. Test records are outlined in Chomerics Test report #EMI5193.08.

We hereby declare that the equipment specified conforms to the above Directives and Standards.



Carl Haapaoja, Director of Quality Assurance

Measurement Computing Corporation
10 Commerce Way
Norton, Massachusetts 02766
(508) 946-5100
Fax: (508) 946-9500
E-mail: info@mccdaq.com
www.mccdaq.com

NI Hungary Kft
H-4031 Debrecen, Hátar út 1/A, Hungary
Phone: +36 (52) 515400
Fax: +36 (52) 515414
<http://hungary.ni.com/debrecen>