

USB-1408FS

14-Bit, 48 kS/s, Multifunction USB Data Acquisition Device



The USB-1408FS offers eight single-ended or four differential analog inputs, two analog outputs, 16 digital I/O, and one counter input.

Overview

The USB-1408FS is a low-cost analog and digital I/O device that offers four differential (DIFF) or eight single-ended (SE) analog inputs, two analog outputs, 16 digital I/O and one event counter.

The device supports sample rates up to 48 kS/s and multiple software-selectable voltage input ranges, making it ideally suited for a wide assortment of measurements.

Analog Input

The USB-1408FS provides eight, 13-bit SE analog inputs or four, 14-bit DIFF analog inputs.

The device supports software-selectable ranges that provide inputs from ± 1 V to ± 20 V in a DIFF configuration, and ± 10 V in a SE configuration.

Sample Rate

When scanning in hardware-paced mode, the USB-1408FS can sample at a maximum of 48 kS/s.

Channel-Gain Queue

The channel-gain queue feature lets you configure a list of channels and gains for each scan. Each channel can have a different gain setting. The gain settings are stored in a channel-gain queue list that is written to local memory on the device.

The USB-1408FS channel-gain queue can contain up to 16 channels listed in any order.

Analog Output

The maximum analog output update rate depends on several factors, including USB port speed.

The USB-1408FS offers two 12-bit analog outputs with a range of 0 V to 4.096 V.

When updating continuously from computer memory (hardware-paced mode), one analog output updates at a maximum rate of 10 kS/s; two analog outputs update simultaneously at a maximum rate of 5 kS/s each.

Digital I/O

The USB-1408FS provides 16 TTL-level digital I/O lines. Digital I/O can be programmed on each 8-bit port (Port A and Port B) for either input (default) or output.

Features

- Low-cost USB DAQ devices with 4 differential or 8 single-ended analog inputs
- Maximum sample rate of 48 kS/s
- 2 analog outputs
- 16 digital I/O
- One 32-bit counter input channel
- No external power required
- Available with enclosure and screw terminals

Supported Operating Systems

- Windows® 10/8/7/Vista®/XP 32/64-bit

Event Counter Input

Each device supports one 32-bit TTL-level counter that accepts inputs up to 1 MHz.

External Clock I/O

Each USB-1408FS device has a bidirectional external clock terminal. When configured for input, A/D conversions can be paced by an external source.

The USB-1408FS supports TTL-level input signals up to 48 kHz.

When configured for output, the device can pace A/D conversions on a second device.

Trigger Input







The USB-1408FS provides an external digital trigger input that is software-selectable for rising or falling edge.

Calibration

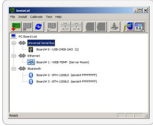
All USB-1408FS devices are factory-calibrated. Specifications are guaranteed for one year. For calibration beyond one year, return the device to the factory for recalibration.

Software Support

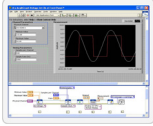
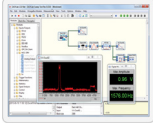
The USB-1408FS is supported by the software in the table below.

Ready-to-Run Applications		
DAQami™		<p>Data acquisition companion software with drag-and-drop interface that is used to acquire, view, and log data, and generate signals. DAQami can be configured to log analog, digital, and counter channels, and to view that data in real-time or post-acquisition on user-configurable displays. Logged data can be exported for use in Excel® or MATLAB®. Windows OS</p> <p>DAQami is included with the free MCC DAQ Software bundle (CD/download). Install DAQami and try the fully-functional software for 30 days. After 30 days, all features except for data logging and data export will continue to be available – data logging and data export features can be unlocked by purchasing the software.</p>
InstaCal™		<p>An interactive installation, configuration, and test utility for MCC hardware. Windows OS</p> <p>InstaCal is included with the free MCC DAQ Software bundle (CD/download).</p>
TracerDAQ™ and TracerDAQ Pro		<p>Virtual strip chart, oscilloscope, function generator, and rate generator applications used to generate, acquire, analyze, display, and export data. Supported features may vary by hardware. The Pro version provides enhanced features. Windows OS</p> <p>TracerDAQ is included with the free MCC DAQ Software bundle (CD/download). TracerDAQ Pro is available as a purchased software download.</p>
General-Purpose Programming Support		
Universal Library™ (UL)		<p>Library for developing applications in C, C++, VB, C# .Net, VB .Net, and Python. Windows OS</p> <p>The UL is included with the free MCC DAQ Software bundle (CD/download).</p>
Linux® driver		<p>Open-source Linux drivers are available for most MCC devices. Example programs are also provided.</p>
Application-Specific Programming Support		
ULx for NI LabVIEW™		<p>A comprehensive library of VIs and example programs for NI LabVIEW that is used to develop custom applications that interact with most MCC devices. Windows OS</p> <p>ULx for NI LabVIEW is included with the free MCC DAQ Software bundle (CD/download).</p>
DASYLab®		<p>Icon-based data acquisition, graphics, control, and analysis software that allows users to create complex applications in minimal time without text-based programming. Windows OS</p> <p>DASYLab is available as a purchased software download. An evaluation version is available for 28 days.</p>
MATLAB® driver		<p>High-level language and interactive environment for numerical computation, visualization, and programming. The Mathworks Data Acquisition Toolbox™ allows users to acquire data from most MCC PCI and USB devices.</p> <p>Visit www.MathWorks.com for more information about the Data Acquisition Toolbox.</p>

USB-1408FS

Specifications



Specifications

All specifications are subject to change without notice.
Typical for 25°C unless otherwise specified.

Analog Input

A/D converter type: Successive approximation

Channels: 8 SE or 4 DIFF, programmable as SE or DIFF

Input common-mode voltage range for linear operation

SE Mode: CHx to GND, ±10 V max

DIFF Mode: CHx to GND, -10 V min, 20 V max

Absolute maximum input voltage: CHx to GND, ±28 V max

Input impedance: 122 kΩ

Input current

V_{in} = 10 V, 70 μA typ

V_{in} = 0 V, -12 μA typ

V_{in} = -10 V, -94 μA typ

Input current is a function of applied voltage on the analog input channels.

For a given input voltage, V_{in}, the input leakage is approximately equal to (8.181 * V_{in}-12) μA

Ranges: Software or selectable on a per-channel basis

SE mode: ±10 V

DIFF mode: ±20 V, ±10 V, ±5 V, ±4 V, ±2.5 V, ±2.0 V, ±1.25 V, ±1.0 V

Throughput

Maximum throughput scanning to computer memory depends on the computer being used.

Software paced: 250 S/s typ, system-dependent

Hardware paced: 50 kS/s

Channel gain queue: Up to 16 elements, software-selectable channel and range

Resolution

DIFF: 12 bits, no missing codes

SE: 11 bits (the AD7870 converter only returns 11-bits (0-2047 codes) in SE mode)

Integral linearity errors: ±1 least significant bit (LSB) typ

Differential linearity error: ±0.5 LSB typ

Absolute accuracy long term drift

±20 V range: 3LSB typ (Δt = 1000 hr)

±4 V range: ±6LSB typ (Δt = 1000 hr)

±1 V range: ±8LSB typ (Δt = 1000 hr)

Extrapolating the long term drift accuracy specifications will provide the approximate long term drift of the USB-1408FS intermediate input ranges.

2.5VREF accuracy (pin 16): ±36.25 mV max

2.5VREF output current (pin 16)

Source: 5 mA max.

Sink: 20 μA min, 100 μA typ

Trigger source (software-selectable)

External digital: TRIG_IN

Analog Input Accuracy		
Range	Absolute Accuracy 25°C	Absolute Accuracy 0°C to 50°C
Differential Mode		
±20 V	±10.98 mV	±49.08 mV
±10 V	±7.32 mV	±33.42 mV
±5 V	±3.66 mV	±20.76 mV
±4 V	±2.92 mV	±19.02 mV
±2.5 V	±1.83 mV	±14.97 mV
±2 V	±1.70 mV	±14.29 mV
±1.25 V	±1.21 mV	±12.18 mV
±1 V	±1.09 mV	±11.63 mV
Single-Ended Mode		
±10 V	±10.98 mV	±49.08 mV

Noise Performance		
Range	Typical Counts	Least Significant Bit ^{Root Mean Square} (LSB _{RMS})
Differential Mode		
±20 V	8	1.21
±10 V	8	1.21
±5 V	9	1.36
±4 V	10	1.51
±2.5 V	12	1.81
±2 V	14	2.12
±1.25 V	18	2.72
±1 V	22	3.33
Single-Ended Mode		
±10 V	8.0	1.21

Analog Output

Resolution: 12 bits, 1 in 4096

Output range: 0 V to 4.096 V, 1 mV per LSB.

Number of channels: 2

Throughput

Maximum throughput scanning to computer memory depends on the computer being used.

Software paced: 250 S/s single channel typ, system-dependent

Hardware paced

Single channel: 10 kS/s

Dual channel: 5 kS/s

Power on and reset voltage: 0 V, ±20 mV typ (initializes to 000h code)

Output drive (each D/A out): 15 mA

Slew Rate: 0.8 V/μs typ

Accuracy (All Values are ±)

0 V to 4.096 V: 4.0 LSB typ, 45.0 LSB max

Analog output accuracy components (all values are ±)

Range: 0 V to 4.096 V

% of FSR: 0.1 typ, 0.9 max

Gain error at full scale: 4.0 mV typ, 36.0 mV max

Offset: 1.0 mV typ, 9.0 mV max

Zero-scale offsets may result in a fixed zero-scale error producing a dead-band digital input code region. In this case, changes in digital input code at values less than 0x040 may not produce a corresponding change in the output voltage. The USB-1408FS offset error is tested and specified at code 0x040.

Accuracy at FS: 4.0 mV typ, 45.0 mV max

Digital I/O

Digital type: CMOS

Number of I/O: 16 (Port A0 through A7, Port B0 through B7)

Configuration: 2 banks of 8

Pull-up/down configuration: All pins pulled up to 5 V through 47 kΩ resistors (default). Change to pull-down using internal user-configurable jumpers.

Hardware with p/n 193331x (where x is the revision letter) may be changed to pull-down using an internal jumper. Other hardware versions can be configured for pull-down at the factory.

Input high voltage: 2.0 V min, 5.5 V absolute max

Input low voltage: 0.8 V max, -0.5 V absolute min, 0 V recommended min

Output high voltage (IOH = -6.0 mA): 3.84 V min

Output low voltage (IOL = 6.0 mA): 0.33 V max

Power on and reset state: Input

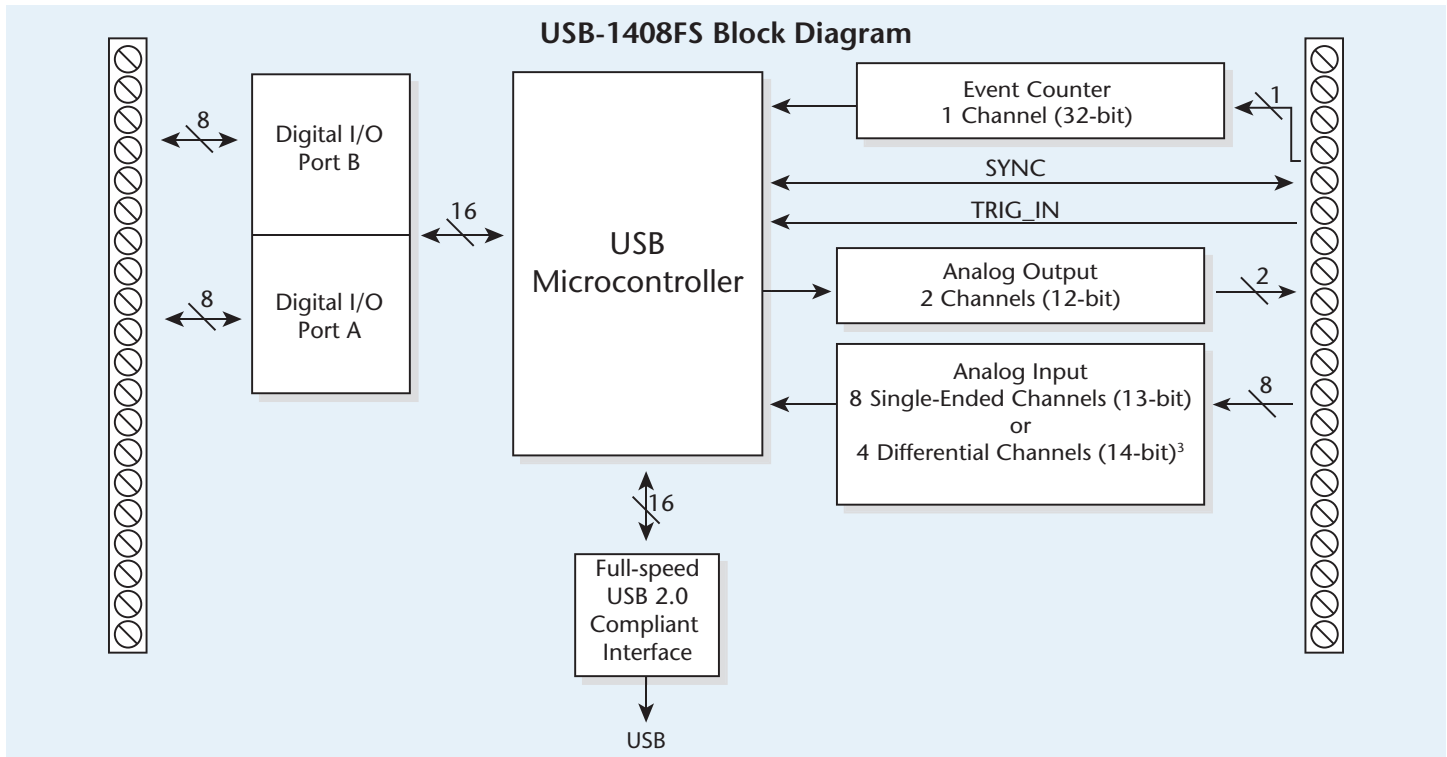

External Trigger

Trigger source: External digital, TRIG_IN
Trigger Mode: Edge sensitive; software-selectable for CMOS compatible rising or falling edge
Trigger latency: 10 μ s max
Trigger pulse width: 1 μ s min
Input type: Schmitt trigger, 47 k Ω pull-down to ground
Schmitt trigger hysteresis: 1.01 V typ, 0.6 V min, 1.5 V max
Input high voltage threshold: 2.43 V typ, 1.9 V min, 3.1 V max
Input high voltage limit: 5.5 V absolute max
Input low voltage threshold: 1.42 V typ, 1.0 V min, 2.0 V max
Input low voltage limit: -0.5 V absolute min, 0 V recommended min

External Clock Input/Output

Pin name: SYNC
Pin type: Bidirectional
Direction (software-selectable)
Input (default): Receives A/D clock from external source. Active on rising edge.
Output: Outputs internal A/D clock. Active on rising edge.
Input clock rate: 48 kHz, max
Clock pulse width
Input mode: 1 μ s min
Output mode: 5 μ s min
Input type: Schmitt trigger, 47 k Ω pull-down to ground
Schmitt trigger hysteresis: 1.01 V typ, 0.6 V min, 1.5 V max
Input high voltage threshold: 2.43 V typ, 1.9 V min, 3.1 V max
Input high voltage limit: 5.5 V absolute max
Input low voltage threshold: 1.42 V typ, 1.0 V min, 2.0 V max
Input low voltage limit: -0.5 V absolute min, 0 V recommended min
Output high voltage: 4.4 V min (IOH = -50 μ A), 3.80 V min (IOH = -8 mA)
Output low voltage: 0.1 V max (IOL = 50 μ A), 0.44 V max (IOL = 8 mA)

Counter

Pin name: CTR
Counter type: Event counter
Number of channels: 1
Input type: Schmitt trigger, 47 k Ω pull-down to ground
Input Source: CTR screw terminal
Resolution: 32 bits

Maximum input frequency: 1 MHz

High pulse width: 500 ns min

Low pulse width: 500 ns min

Schmitt trigger hysteresis: 1.01 V typ, 0.6 V min, 1.5 V max

Input high voltage threshold: 2.43 V typ, 1.9 V min, 3.1 V max

Input high voltage limit: 5.5 V absolute max

Input Low voltage threshold: 1.42 V typ, 1.0 V min, 2.0 V max

Input low voltage limit: -0.5 V absolute min, 0 V recommended min

Non-Volatile Memory

EEPROM: 1,024 bytes

EEPROM configuration

Address 0x000 to 0x1FF: Read/write access, 512 bytes user area

Address 0x200 to 0x3FF: Read/write with unlock, 512 bytes calibration data

Power

Supply current: 80 mA (total current requirement; includes up to 10 mA for the status LED)

5 V USB power available

Connected to self-powered hub: 4.5 V min, 5.25 V max

Connected to bus-powered hub: 4.1 V min, 5.25 V max

Output Current (total amount of current that can be sourced from the USB 5 V, analog outputs and digital outputs)

Connected to self-powered hub or externally powered

Root port hub: 420 mA max

Connected to bus-powered hub: 20 mA max

Self-powered USB hubs and hosts have their own power supply. The USB port(s) on your computer are root port hubs. All externally powered root port hubs (desktop computers) provide up to 500 mA of current for a USB device. Battery-powered root port hubs provide 100 mA or 500 mA, depending upon the manufacturer. A laptop PC that is not connected to an external power adapter is an example of a battery-powered root port hub.

Bus-powered USB hubs and hosts do not have their own power supply.

USB-1408FS



Ordering

General

Device type: USB 2.0 full-speed
Device compatibility: USB 1.1, 2.0

Environmental

Operating temperature: 0 °C to 70 °C
Storage temperature: -40 °C to 70 °C
Relative humidity: 0% to 90% non-condensing

Mechanical

Dimensions (L × W × H): 79 × 82 × 27 mm (3.20 × 3.10 × 1.05 in.)
USB cable length: 3 m (9.84 ft) max
User connection length: 3 m (9.84 ft) max

Screw Terminal Connector

Connector type: Screw terminal
Wire gauge range: 16 AWG to 30 AWG

Order Information

Hardware

Part No.	Description
USB-1408FS	USB-based data acquisition device with 8 analog inputs, up to 14-bit resolution, 48 kS/s, two analog outputs, and 16 digital I/O. Includes USB cable and MCC DAQ software CD.

Software also Available from MCC

Part No.	Description
DAQami	Data acquisition companion software for acquiring data and generating signals
TracerDAQ Pro	Out-of-the-box virtual instrument suite with strip chart, oscilloscope, function generator, and rate generator – professional version
DASYLab	Icon-based data acquisition, graphics, control, and analysis software