

USB-1616FS

Simultaneous Sampling Multifunction DAQ Device



The USB-1616FS features simultaneous sampling of 16 single-ended analog inputs, 8 DIO lines, and a 32-bit event counter

Features

- 16 single-ended analog inputs
- 16-bit resolution
- Up to 200 kS/s throughput
- Simultaneous sampling
- 8 digital I/O
- 32-bit counter
- Integrated temperature sensor
- USB expansion port for multi-unit daisy-chaining
- External power adapter
- Rugged enclosure
- DIN rail or bench mountable

Supported Operating Systems

- Windows® 10/8/7/Vista®XP, 32/64-bit

Overview

The USB-1616FS provides 16 simultaneously sampled 16-bit analog inputs with sample rates up to 50 kS/s per channel, continuous throughputs of 150 kS/s, and 32 kilosample bursts up to 200 kS/s. The device also provides one 32-bit counter and 8 digital I/O lines.

The USB-1616FS design features a heavy-duty chassis with integrated mounting slots, ensuring that the device is rugged enough for any DAQ application.

The combination of the USB-1616FS and Measurement Computing DAQ software suite gives you a complete data acquisition solution that will have you taking measurements in minutes. The device is fully USB plug and play. An external power adapter is included.

Analog Input

The USB-1616FS provides 16 single-ended analog inputs. A channel gain queue feature lets users set up a scan list to sample up to 16 different analog input channels at different gains (ranges).

Simultaneous Sampling

Each analog input channel has a dedicated 16-bit A/D converter for true simultaneous sampling of all 16 inputs.

Sample Rates

With hardware paced mode, the maximum throughput rate is 50 kS/s for one channel, or 9.5 kS/s per channel for all channels.

With burst scan mode, the maximum throughput rate is 50 kS/s per channel for one, two, or three channels, and 16.5 kS/s per channel for all 16 channels.

Digital I/O

Eight digital IO lines are independently selectable as input or output. All digital lines are pulled up by default with a 47 k Ω resistor.

Counter Input

The 32-bit event counter accepts frequency inputs up to 1 MHz, and increments when the TTL level transitions from low to high.

Trigger Input

The USB-1616FS has an external digital trigger input. The trigger mode is configurable with software for rising (default) or falling edge.

External Clock I/O

A bidirectional SYNC (synchronization) control line can be configured as either input or output.

Configure as an external clock input to externally clock A/D conversions, or as an output to synchronize with a second USB-1616FS and acquire data from 32 channels.

USB-1616FS

Software

Calibration

USB-1616FS devices are factory-calibrated using a NIST-traceable calibration process. Specifications are guaranteed for one year. For calibration beyond one year, return the device to the factory for recalibration.

Power





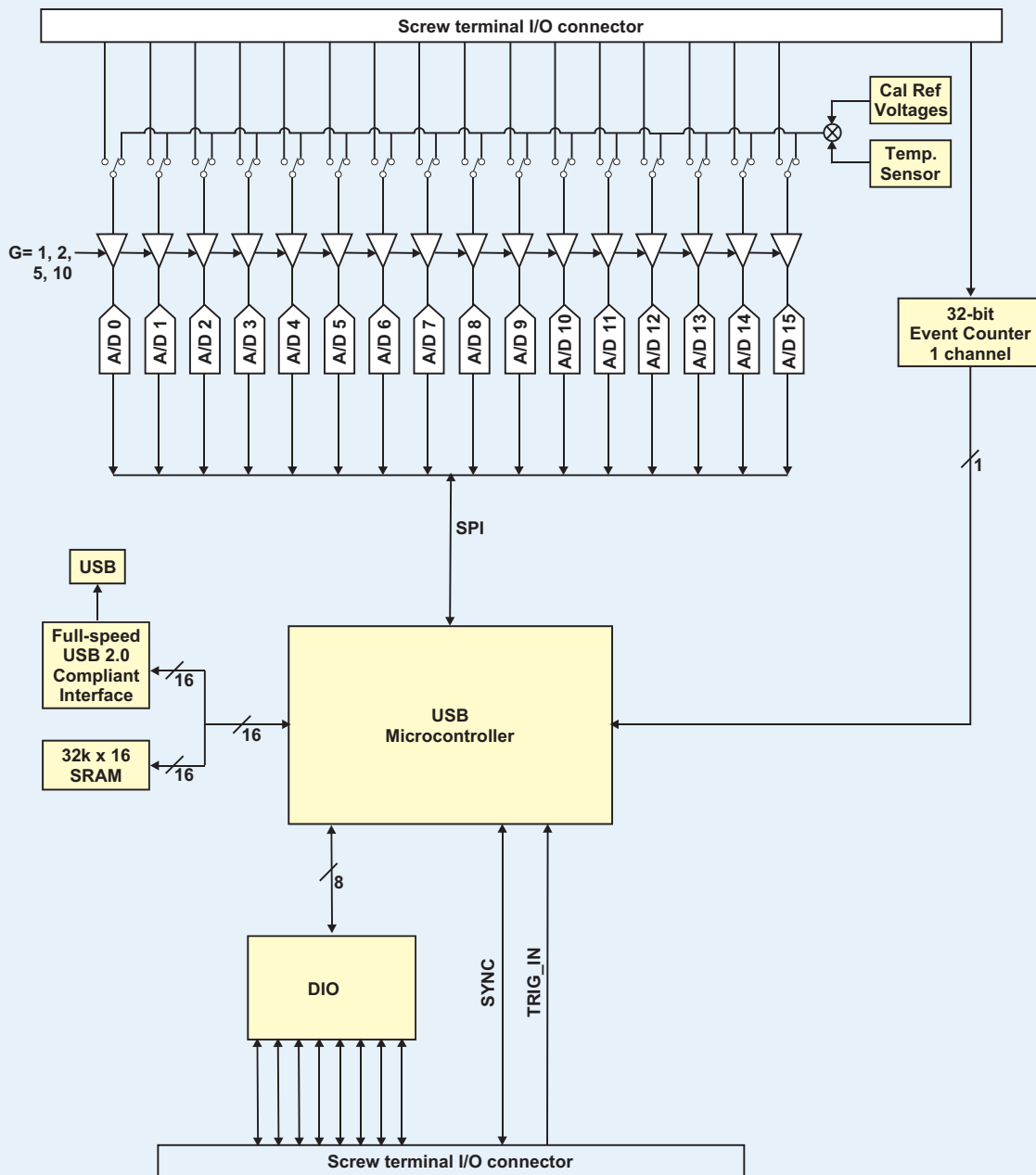

The USB-1616FS receives power from the +9 V unregulated power supply that is shipped with the device. Power and USB connectors let you power and control multiple MCC USB Series products from one external power source and one USB port in a daisy chain fashion.

USB-1616FS Block Diagram

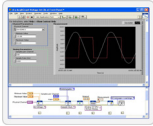

Software Support

USB-1616FS devices are supported by the software in the table below.

Ready-to-Run Applications	
DAQami™	 <p>Data acquisition companion software with drag-and-drop interface that is used to acquire, view, and log data, and generate signals. DAQami can be configured to log analog, digital, and counter channels, and to view that data in real-time or post-acquisition on user-configurable displays. Logged data can be exported for use in Excel® or MATLAB®. Windows OS</p> <p>DAQami is included with the free MCC DAQ Software bundle (CD/download). Install DAQami and try the fully-functional software for 30 days. After 30 days, all features except for data logging and data export will continue to be available – data logging and data export features can be unlocked by purchasing the software.</p>
InstaCal™	 <p>An interactive installation, configuration, and test utility for MCC hardware. Windows OS</p> <p>InstaCal is included with the free MCC DAQ Software bundle (CD/download).</p>
TracerDAQ™ and TracerDAQ Pro	 <p>Virtual strip chart, oscilloscope, function generator, and rate generator applications used to generate, acquire, analyze, display, and export data. Supported features may vary by hardware. The Pro version provides enhanced features. Windows OS</p> <p>TracerDAQ is included with the free MCC DAQ Software bundle (CD/download).</p> <p>TracerDAQ Pro is available as a purchased software download.</p>
General-Purpose Programming Support	
Universal Library™ (UL)	 <p>Library for developing applications in C, C++, VB, C# .Net, VB .Net, and Python. Windows OS</p> <p>The UL is included with the free MCC DAQ Software bundle (CD/download).</p>
Linux® driver	 <p>Open-source Linux drivers are available for most MCC devices. Example programs are also provided.</p>
Application-Specific Programming Support	
ULx for NI LabVIEW™	 <p>A comprehensive library of VIs and example programs for NI LabVIEW that is used to develop custom applications that interact with most MCC devices. Windows OS</p> <p>ULx for NI LabVIEW is included with the free MCC DAQ Software bundle (CD/download).</p>
DASYLab®	 <p>Icon-based data acquisition, graphics, control, and analysis software that allows users to create complex applications in minimal time without text-based programming. Windows OS</p> <p>DASYLab is available as a purchased software download. An evaluation version is available for 28 days.</p>
MATLAB® driver	 <p>High-level language and interactive environment for numerical computation, visualization, and programming. The Mathworks Data Acquisition Toolbox™ allows users to acquire data from most MCC PCI and USB devices.</p> <p>Visit www.MathWorks.com for more information about the Data Acquisition Toolbox.</p>

USB-1616FS

Specifications



Specifications

Analog Input

A/D converters: 16-bit, SAR type
Number of channels: 16 single-ended
Input configuration: Individual A/D per channel
Sampling method: Simultaneous
Absolute maximum input voltage: CHx IN to GND ±15 V max
Input impedance: 100 MΩ, min
Input bandwidth (–3 dB): 50 kHz typ
Input leakage current: ±1 μA typ
Input capacitance: 50 pf typ
Offset temperature drift: 15 ppm/°C typ
Gain temperature drift: All ranges 35 ppm/°C typ
Input ranges: ±10 V, ±5 V, ±2 V, ±1 V; Software selectable
Sampling rate
Scan to PC memory: up to 50 kS/s, software selectable
Burst scan to 32 k sample FIFO: 20 S/s to 50 kS/s, software selectable
Throughput: Software paced; 30 S/s to 500 S/s all channels; system dependant
Scan to PC memory: Refer to the throughput tables below.
Burst scan to 32 k sample FIFO: (200 kS/s)/(# of channels); 50 kS/s max for any channel
Gain queue: Queue list may contain up to 16 unique, consecutive channels paired with any valid range; software configurable
Resolution: 16 bits
No missing codes: 15 bits
Crosstalk
DC – 25 kHz (sine): –80 dB min
Calibration voltages: 0 V, ±0.625 V, ±1.25 V, ±2.5 V, ±5.0 V, software selectable
Calibration voltage accuracy (Note 1): ±0.5% typ, ±1.0% max
Temperature sensor range: 0 °C to +70 °C max
Temperature sensor accuracy: ±3 °C typ
Trigger source: External digital; TRIG_IN; software selectable

Single Board Throughput

An integral USB hub allows up to four USB-1616FS devices to be daisy chained and connected to a single USB port on the host computer. We recommend using a 2.0 or higher USB adapter when daisy chaining devices. Data in the following table reflects typical throughput for a single board system.

Single-Board Throughput; Scan to PC Memory	
Number of Input Channels	Per channel throughput (kS/s)
1	50000
2	50000
3	36000
4	30000
5	25000
6	22000
7	19000
8	17000
9	15000
11	14000
12	12500
13	11250
14	10500
15	10000
16	9500

The throughput rates apply to a single board system. Actual rates are system-dependent and may vary.

Multiple board throughput

An integral USB hub allows up to four USB-1616FS devices to be daisy chained and connected to a single USB port on the host computer. Revision F and later are compatible with USB 3.0. Older revisions can be daisy chained from a Revision F device attached to a USB 3.0 adapter. Refer to “[Board Revision](#)” below for revision information.

Data transfer over the USB bus is CPU intensive and system dependent. Multiple board performance is limited by an overall aggregate sample rate. The maximum throughput is the number of samples taken per second, regardless of the number of channels sampled or number of devices installed. The maximum sample rate of any one channel is limited to 50 kS/s.

For example, if the maximum throughput is 150,000 S/s, you may sample 20 channels at 7.5 kS/s, 30 channels at 5 kS/s, 40 channels at 3.75 kS/s, and so on.

Board Revision

The board revision may be determined from the part number label on the board that states “193337X-01L”, where X is the board revision.

Calibrated Absolute Accuracy	
Range (V)	Accuracy (mV)
±10	±5.66
±5	±2.98
±2	±1.31
±1	±0.68

Accuracy components			
Range (V)	% of Reading	Gain Error at FS (mV)	Offset (mV)
±10	0.04	4.00	1.66
±5	0.04	2.00	0.98
±2	0.04	0.80	0.51
±1	0.04	0.40	0.28

All values are (±)

Noise Performance		
Range (V)	Typical Counts	LSBrms
±10	10	1.52
±5	10	1.52
±2	11	1.67
±1	14	2.12

Noise distribution is determined by gathering 50 k samples with analog inputs tied to ground (AGND) at the user connector. Samples are gathered at the maximum specified sampling rate of 50 kS/s.

Digital I/O

Digital type: CMOS

Number of I/O: 8 (DIO0 through DIO7)

Configuration: Independently configurable for input or output

Digital I/O transfer rate (software paced): System dependent, 33 port reads to 1000 port reads/writes or single bit reads/writes per second, typ

Input high voltage: 2.0 V min, 5.5 V absolute max

Input low voltage: 0.8 V max, –0.5 V absolute min

Output high voltage (IOH = –2.5 mA): 3.8 V min

Output low voltage (IOL = 2.5 mA): 0.7 V max

Power on and reset state: Input

Pull up/down configuration

Earlier than Revision F: All pins pulled up to USB VBUS via 47 kΩ resistors (default). Positions are available for pull-down to ground (GND). Hardware selectable via 0 Ω resistors is available as a factory option.

Revision F and later: All pins are configurable via jumper W1 to 5 V or ground via 47 kΩ resistors.

Refer to the “[Board Revision](#)” discussion above for revision information.

USB-1616FS

Ordering



External Trigger

Trigger source: External digital; TRIG_IN; Schmitt trigger protected with 1.5 k Ω series resistor.

Trigger mode: Edge sensitive; software selectable for rising (default) or falling edge.

Trigger latency: 10 μ s max

Trigger pulse width: 1 μ s min

Earlier than Revision F

Input type: Schmitt trigger, 1.5 k Ω series resistor

Input high voltage: 4.0 V min, 5.5 V absolute max

Input low voltage: 1.0 V max, -0.5 V min

Input leakage current: \pm 1.0 μ A

Revision F and later

Input type: Schmitt trigger, 47 k Ω pull-down to ground and 1.5 k Ω series resistor

Schmitt trigger hysteresis: 0.6 V min, 1.5 V max

Input high voltage threshold: 3.1 V max

Input low voltage threshold: 1.0 V min

Refer to the "Board Revision" on page 4 for revision information.

External Clock I/O

Pin name: SYNC; Schmitt trigger over-current protected with a 200 Ω series resistor.

Pin type: Bidirectional

Software selectable direction

Output: Outputs internal A/D pacer clock

Input: Receives A/D pacer clock from external source. Rising edge sensitive.

Input clock rate: 50 kHz, max

Clock pulse width

Input: 1 μ s min

Output: 5 μ s min

Earlier than Revision F

Input type: Schmitt trigger with 200 Ω series resistor

Input/output resistance: 200 Ω series resistor

Input leakage current: \pm 1.0 μ A

Input high voltage: 4.0 V min, 5.5 V absolute max

Input low voltage: 1.0 V max, -0.5 V absolute min

Output high voltage

IOH = -2.5 mA: 3.3 V min

No load: 3.8 V min

Output low voltage

IOL = 2.5 mA: 1.1 V max

No load: 0.6 V max

Revisions F and later

Input type: Schmitt trigger

Input/output resistance: 200 Ω series resistor on output driver; 1.5 k Ω series resistor on input buffer; 47 k Ω pull-down resistor to ground

Schmitt trigger hysteresis: 0.6 V min, 1.5 V max

Input high voltage threshold: 3.1 V max

Input low voltage threshold: 1.0 V min

Output high voltage

IOH = -8 mA: 3.8 V min

No load: 4.4 V min

Output low voltage

IOH = 8 mA: 0.44 V max

No load: 0.1 V max

Refer to the "Board Revision" on page 4 for revision information.

Counter

Pin name: CTR

Counter typ: Event counter

Number of channels: 1

Resolution: 32 bits

Maximum input frequency: 1 MHz

High pulse width: 500 ns min

Low pulse width: 500 ns min

Counter/timer read/write rates (software paced)

Counter read: system dependent, 33 reads to 1,000 reads per second

Counter clear: system dependent, 33 reads to 1,000 writes per second

Input low voltage limit: 0 V recommended min, -0.5 V absolute min

Input high voltage limit: 5.0 V recommended max, 5.5 V absolute max

Earlier than Revision F

Input type: Schmitt trigger, rising edge triggered, 1.5 k Ω series resistor

Schmitt trigger hysteresis: 20 mV to 100 mV

Input leakage current: \pm 1.0 μ A

Input high voltage threshold: 1.0 V min

Input low voltage threshold: 4.0 V max

Revision F and later

Input type: Schmitt trigger, rising edge triggered, 1.5 k Ω series resistor, 47 k Ω pull-down to ground

Schmitt trigger hysteresis: 0.6 V min, 1.5 V max

Input high voltage threshold: 3.1 V max

Input low voltage threshold: 1.0 V min

Refer to the "Board Revision" on page 4 for revision information.

Power

Supply current

Continuous mode: 350 mA typ; includes up to 10 mA for the status LEDs

User +5V output voltage: 4.0 V min, 5.25 V max; available at the 5V screw terminal; assumes input power supply voltage is within specified limits

User +5V output current: 50 mA max; available at the 5V screw terminal

USB +5V (VBUS) input voltage: 4.75 V min to 5.25 V max

External Power

External power adapter (included): CB-PWR-9V3A; +9 V \pm 10%, @ 3 A. If the limit is exceeded, the PWR LED turns off, indicating a power fault condition.

External power input: +6.0 VDC to 12.5 VDC; 9 VDC power supply included.

Voltage supervisor limits - PWR LED:

6.0 V > Vext or Vext > 12.5 V: PWR LED = Off (power fault)

6.0 V < Vext < 12.5 V: PWR LED = On

External power output - current range: 4.0 A max. The voltage drop between power input and daisy chain power output: 0.5 V max

Compatible cable(s) for daisy chain: C-MAPWR-x; x = 2, 3 or 6 feet

Environmental

Operating temperature range: 0 $^{\circ}$ C to 70 $^{\circ}$ C

Storage temperature range: -40 $^{\circ}$ C to 85 $^{\circ}$ C

Humidity: 0% to 90% non-condensing

Mechanical

Card dimensions (L \times W \times H): 203.2 \times 121.9 \times 20.0 mm (8.0 \times 4.8 \times 0.8 in.)

Enclosure dimensions (L \times W \times H): 241.3 \times 125.7 \times 58.9 mm (9.50 \times 4.95 \times 2.32 in.)

USB Specifications

USB device type: USB 2.0 (full-speed)

USB compatibility: USB 3.0, 2.0, 1.1

Order Information

Hardware

Part No.	Description
USB-1616FS	Multifunction USB DAQ device with simultaneous sampling, 16-bit analog inputs, 200 kS/s sampling, 32-bit event counter, and 8 digital I/O lines.
CB-PWR-9V3A	9 volt replacement power supply.

Software also Available from MCC

Part No.	Description
DAQami	Data acquisition companion software for acquiring data and generating signals
TracerDAQ Pro	Out-of-the-box virtual instrument suite with strip chart, oscilloscope, function generator, and rate generator - professional version
DASYLab	Icon-based data acquisition, graphics, control, and analysis software